

30V N-Ch Power MOSFET

Feature

- ◇ Optimized for high speed switching, Logic Level
- ◇ Enhanced Body diode dv/dt capability
- ◇ Enhanced Avalanche Ruggedness
- ◇ 100% UIS Tested, 100% Rg Tested
- ◇ Lead Free, Halogen Free

Application

- ◇ Synchronous Rectification in SMPS
- ◇ Hard Switching and High Speed Circuit
- ◇ Power Tools
- ◇ UPS
- ◇ Motor Control

V_{DS}		30	V
$R_{DS(on),max}$	$V_{GS}=10V$	2.9	$m\Omega$
$R_{DS(on),max}$	$V_{GS}=4.5V$	4	$m\Omega$
I_D		122	A

DFN5x6

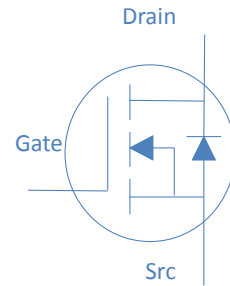

Part Number	Package	Marking
HTN027N03P	DFN5x6	TN027N03P

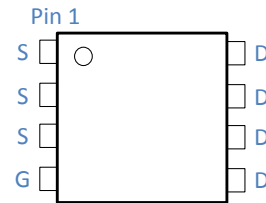

Absolute Maximum Ratings at $T_j=25^\circ\text{C}$ (unless otherwise specified)

Parameter	Symbol	Conditions	Value	Unit
Continuous Drain Current (Silicon Limited)	I_D	$T_C=25^\circ\text{C}$	122	A
		$T_C=100^\circ\text{C}$	77	
Drain to Source Voltage	V_{DS}	-	30	V
Gate to Source Voltage	V_{GS}	-	± 20	V
Pulsed Drain Current	I_{DM}	-	103	A
Avalanche Energy, Single Pulse	E_{AS}	$L=0.1\text{mH}, T_C=25^\circ\text{C}$	101	mJ
Power Dissipation	P_D	$T_C=25^\circ\text{C}$	78	W
Operating and Storage Temperature	T_J, T_{stg}	-	-55 to 150	$^\circ\text{C}$

Absolute Maximum Ratings

Parameter	Symbol	Max	Unit
Thermal Resistance Junction-Case	$R_{\theta JC}$	1.6	$^\circ\text{C/W}$
Thermal Resistance Junction-Ambient	$R_{\theta JA}$	55	$^\circ\text{C/W}$

Electrical Characteristics at $T_j=25^\circ\text{C}$ (unless otherwise specified)
Static Characteristics

Parameter	Symbol	Conditions	Value			Unit
			min	typ	max	
Drain to Source Breakdown Voltage	$V_{(BR)DSS}$	$V_{GS}=0V, I_D=250\mu A$	30	-	-	V
Gate Threshold Voltage	$V_{GS(th)}$	$V_{GS}=V_{DS}, I_D=250\mu A$	1	-	2	
Zero Gate Voltage Drain Current	I_{DSS}	$V_{GS}=0V, V_{DS}=24V, T_j=25^\circ\text{C}$	-	-	1	μA
Gate to Source Leakage Current	I_{GSS}	$V_{GS}=\pm 20V, V_{DS}=0V$	-	-	± 100	nA
Drain to Source on Resistance	$R_{DS(on)}$	$V_{GS}=10V, I_D=20A$	-	-	2.9	$m\Omega$
		$V_{GS}=4.5V, I_D=15A$	-	-	4.0	$m\Omega$
Transconductance	g_{fs}	$V_{DS}=10V, I_D=5A$	-	15	-	S
Gate Resistance	R_G	$V_{GS}=0V, V_{DS}$ Open, $f=1\text{MHz}$	-	2.6	-	Ω

Dynamic Characteristics

Input Capacitance	C_{iss}	$V_{GS}=0V, V_{DS}=15V, f=1\text{MHz}$	-	4242	-	pF
Output Capacitance	C_{oss}		-	492	-	
Reverse Transfer Capacitance	C_{rss}		-	329	-	
Total Gate Charge (10V)	$Q_g (10V)$	$V_{DD}=25V, I_D=14A, V_{GS}=10V$	-	88	-	nC
Gate to Source Charge	Q_{gs}		-	7	-	
Gate to Drain (Miller) Charge	Q_{gd}		-	24	-	
Turn on Delay Time	$t_{d(on)}$	$V_{DD}=15V, I_D=1A, V_{GS}=10V, R_G=2.5\Omega,$	-	33	-	ns
Rise time	t_r		-	23	-	
Turn off Delay Time	$t_{d(off)}$		-	72	-	
Fall Time	t_f		-	25	-	

Reverse Diode Characteristics

Diode Forward Voltage	V_{SD}	$V_{GS}=0V, I_F=15A$	-	0.79	1.1	V
Reverse Recovery Time	t_{rr}	$I_F=15A, dI_F/dt=100A/\mu s$	-	19.8	-	ns
Reverse Recovery Charge	Q_{rr}		-	8.7	-	nC

Fig 1. Typical Output Characteristics

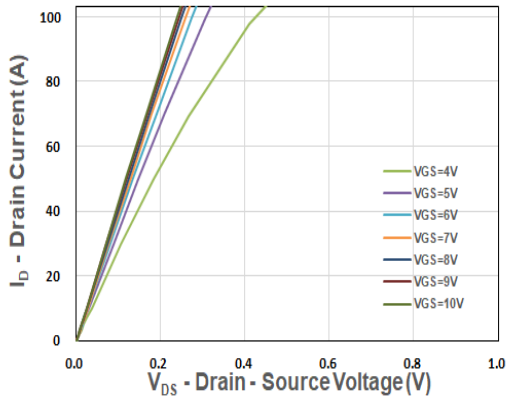

Figure 2. On-Resistance vs. Gate-Source Voltage

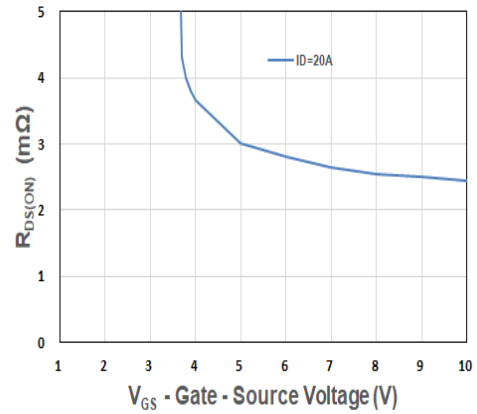

Figure 3. On-Resistance vs. Drain Current and Gate Voltage

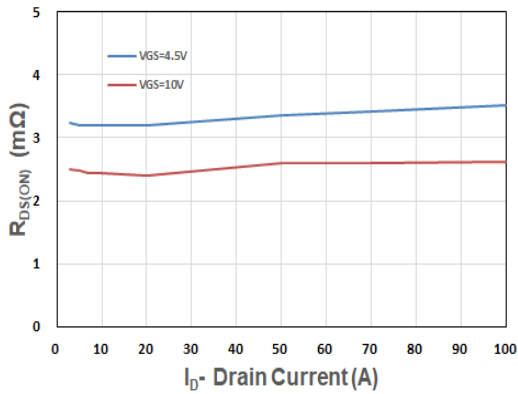

Figure 4. Normalized On-Resistance vs. Junction Temperature

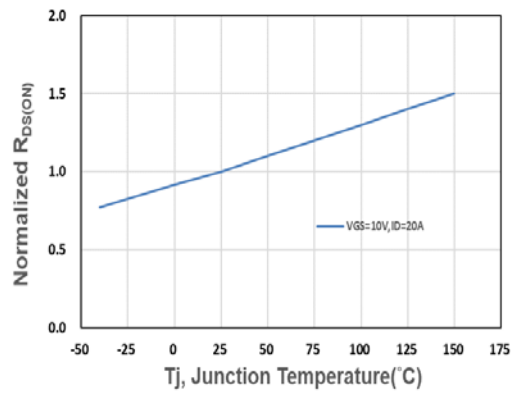

Figure 5. Normalized Breakdown Voltage VS Junction Temperature

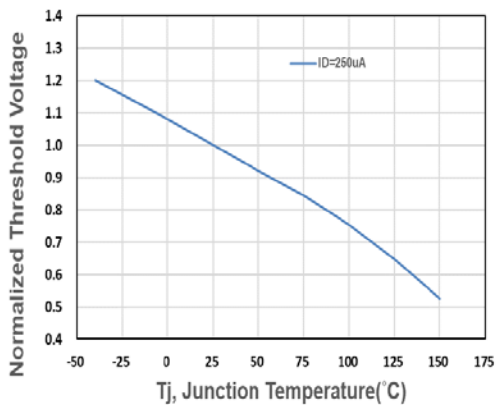

Figure 6. Typical Source-Drain Diode Forward Voltage

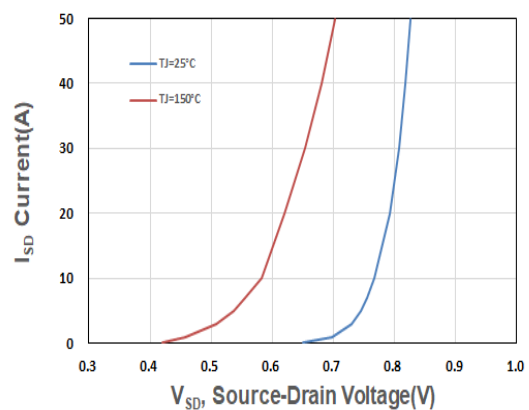

Figure 7. Typical Gate-Charge vs. Gate-to-Source Voltage

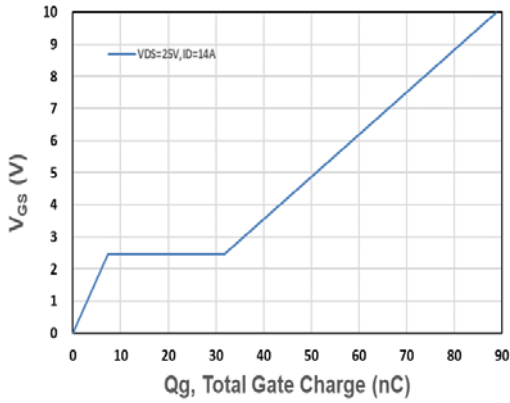

Figure 8. Typical Capacitance vs. Drain-to-Source Voltage

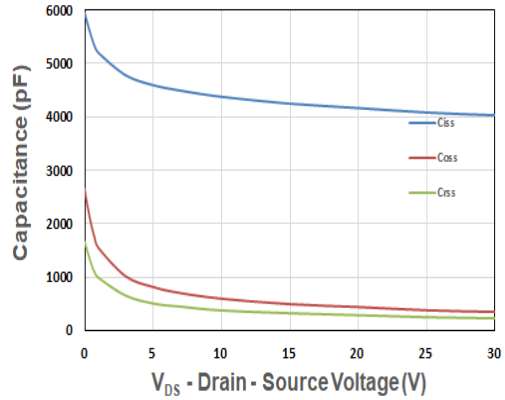

Figure 9. Maximum Safe Operating Area

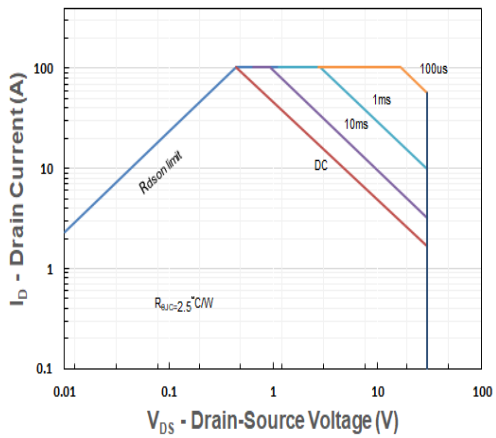

Figure 10. Maximum Drain Current vs. Case Temperature

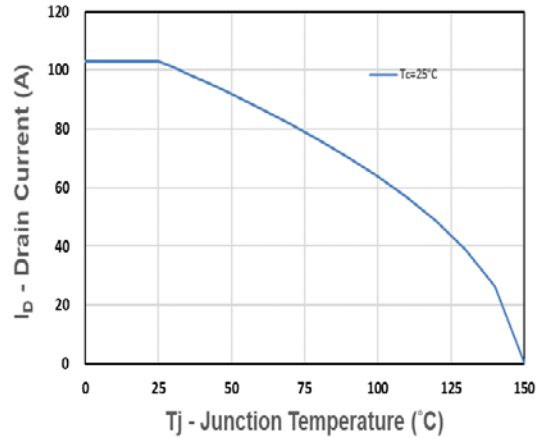
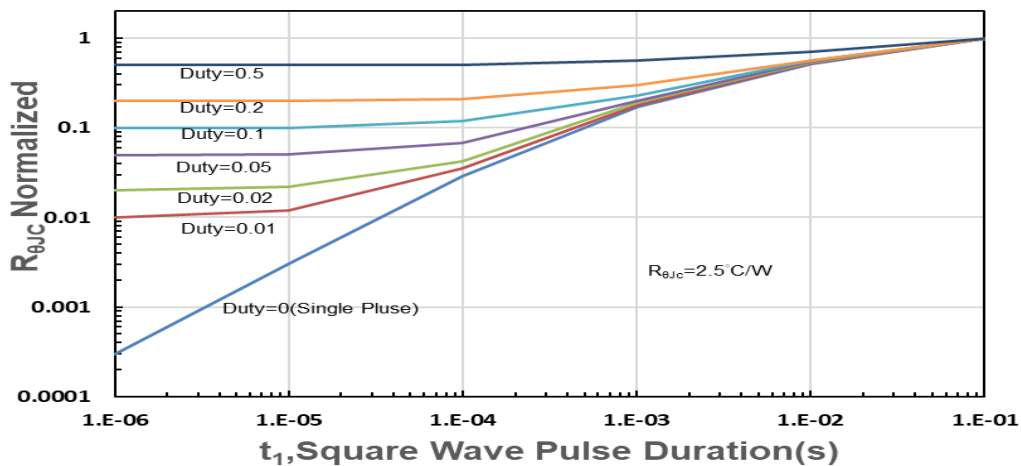
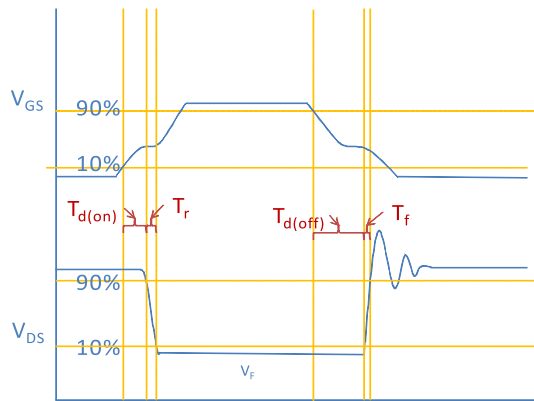
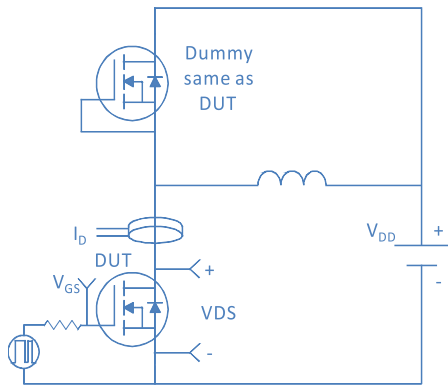

Figure 11. Normalized Maximum Transient Thermal Impedance, Junction-to-Case



Inductive switching Test



Gate Charge Test

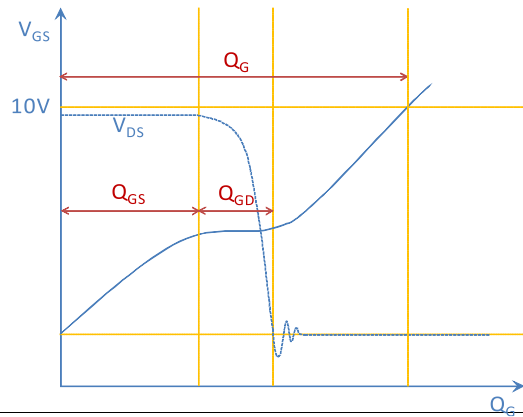
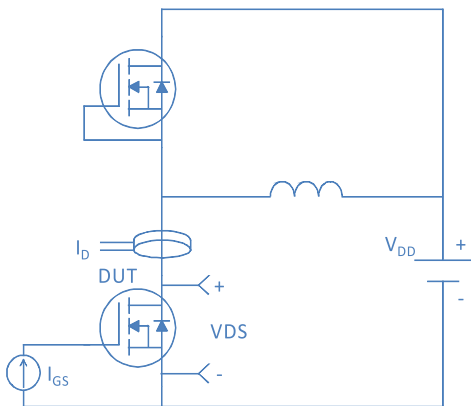

Uclamped Inductive Switching (UIS) Test

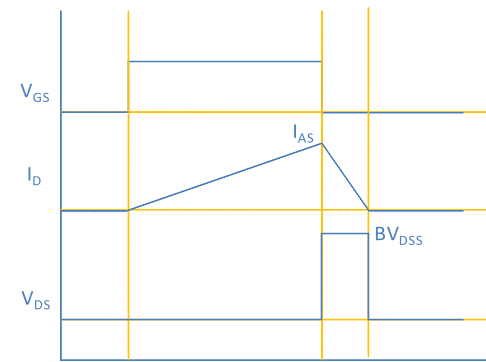

Diode Recovery Test

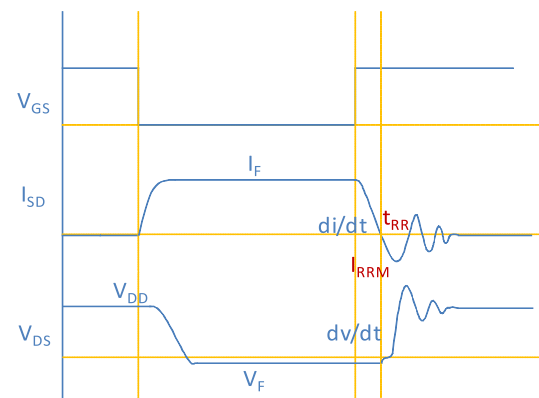
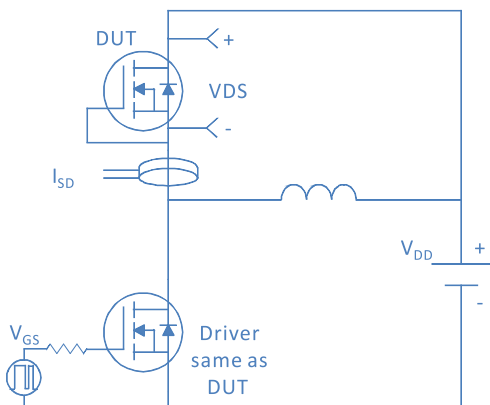

Package Outline

DFN5x6_P, 8 Leads

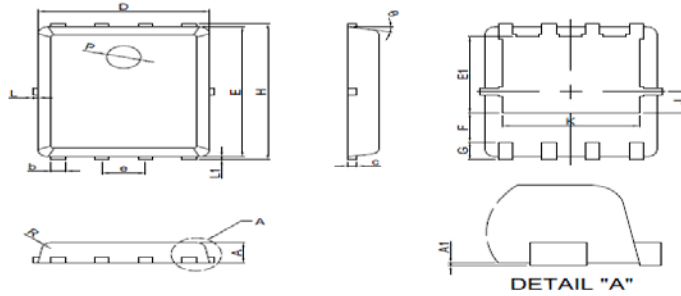

SYMBOL	MILLIMETERS		INCHES	
	MIN	MAX	MIN	MAX
A	0.80	1.00		
A1	0.00	0.05		
b	0.35	0.49		
c	0.254 REF			
D	4.90	5.10	0.193	0.201
F	1.4 REF			
E	5.70	5.90	0.224	0.232
e	1.27 BSC			
H	5.95	6.20	0.234	0.244
L1	0.10	0.18		
G	0.6 REF			
K	4 REF			
L		0.15		
J	0.95 BSC			
P	1 REF			
E1	3.4 REF			
Ø	6°	14°		
R	0.25 REF			